

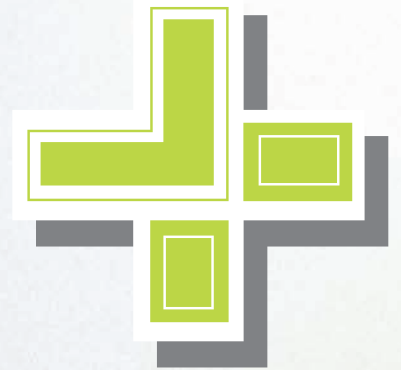

LED COLLECTION



MODUL
LED
CURVE PROFILE
CLEARVIEW
PUREVIEW
8000K

ABOUT US

Reliable, functional design, technical performance, versatility, durable, maintenance convenience; they are the product development obsessions of MILUX. With more than 30 years in producing lighting products, our production team has assimilated their experience and innovation technology to lead the market in aesthetics as well as performance at internationally recognised standards.

In order to guarantee the highest quality level from raw material to final stage inspection, our quality control system plays an important role in our production process. In addition to the propriety product from our collection, the production team also has the capability to customise and develop client's original design to a certified product. MILUX is an obvious solution to cater for your wide range of applications with a competitive price range in the market.





OEM & ODM Services

Milux employs a dedicated OEM and ODM team of experienced engineers and designers to create luminaires to your specification. Our expertise ensures your designs meet with industry standards and maintain high levels of quality and finish. We oversee every step of the process from design, manufacturing to after sales customer service and offers the safest, most reliable and cost effective LED solution.

What

is matter ?

Matter is a smart home standard designed to unify the fragmented market of smart devices. It creates a common language for these devices, allowing them to work seamlessly together across different systems. Matter is an innovative standard designed to enhance smart homes and improve interoperability among various devices.

Interoperability

Interoperability Across Ecosystems:

- Matter allows different smart homes (such as Apple HomeKit, Google Home, and Amazon Alexa) to communicate seamlessly.
- You can mix and match devices from various brands without compatibility issues.

Flexible Device Compatibility:

- Suppose you switch from one smartphone brand to another (e.g. Samsung to iPhone). Matter ensures that your smart devices remain usable regardless of your phone choice.
- Matter-compatible devices work with Android, iOS, and other platforms.

Stability and Reliability:

- Matter supports connection methods like Wi-Fi, Thread, and Ethernet.
- It ensures faster, more responsive, and stable connections for your smart home devices.

Enhanced Security:

- Matter operates locally on your device, reducing external hacking risks.
- It adheres to consistent security protocols, ensuring high safety standards for all Matter devices.

Certified Manufacturers:

- Major brands like Amazon, Apple, Google, Samsung, and Zigbee Alliance support Matter.
- Other manufacturers, including Eve, Meross, and Linkind, have also joined the Matter ecosystem.

Future-Proofing Your Smart Home:

- Matter simplifies integration and is expected to become more widespread.
- If you're building a smart home, Matter is a promising standard to consider.

Matter acts as a bridge, allowing your smart devices to converse fluently across different systems. Whether you're upgrading existing devices or purchasing new ones, Matter offers a reliable and secure solution for your smart home needs!



| E-CATALOGUE |

Download the latest version



Modular Innovative Lighting Solutions

The Milux latest product range embraces the modularised concept, reflecting the market trends towards flexibility and customisation.

The adaptive Curvity offers customisable curves, angles, and widths, while the high performing ClearView and PureView maximise office brightness with anti-glare covers for exceptional vision comfort. Freeplus 8° LED Modules provides precise spotlighting, and Freeplus RGBCW modules offers tunable colours for various environments, enhancing mood and health. These new additions will ensure the already flexible Freeplus family becomes even more comprehensive. This catalogue showcases our commitment to versatile, easy-to-install, and maintainable lighting solutions, allowing for creative and adaptable applications across diverse settings.

By integrating modularity, we cater to the growing demand for personalised and efficient lighting, ensuring that each product can be seamlessly interchanged and adapted to meet specific needs, fostering innovation and creativity in lighting design.

INDEX

1	Curve Profile Curvity 60 Curvity 80	9
2	Profile System ClearView PureView	17
3	Freeplus Module Full Spectrum Freeplus 8° Freeplus RGBCW <i>Compatible with</i> Renia Glee Pin Hole Pin Slot Mini Trim Mini Trim Sq	23



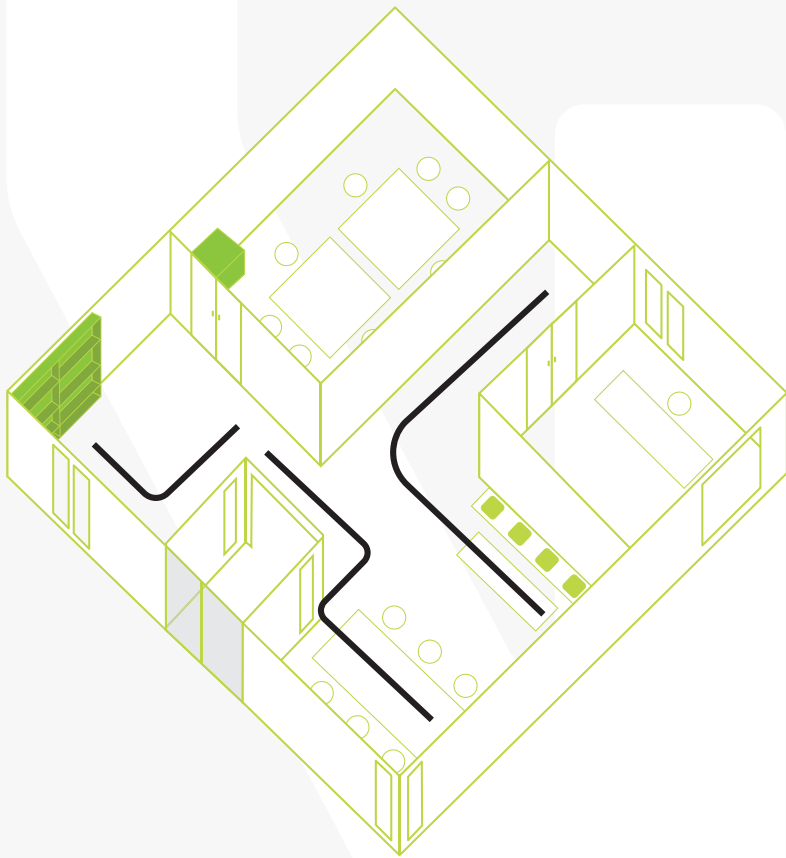

CURVITY



Extensive Modular Configuration

Our Curvity modular system features an extensive range of curves with radius starts from 250mm up to 450mm, curve angle from 30° to 90°, and width from 60mm to 200mm. With the aid of straight profile ranged from 300mm to 3000mm, your creativity will see no boundary. Length could be custom made to achieve different imagination.

Multi-Directional Light

The powerful pendant profile supports both up and downlight to provide ample lumen in your interiors. Surface mount version is also available for a wide range of applications.

Easy Maintenance Mechanism (Front Panel Access)

Installation and maintenance have not been easier. A newly developed front diffuser removal and easy connecting mechanism.



MILUX
MODUL-
VARISEO

*“Curve beyond limits,
illuminate boundlessly.”*

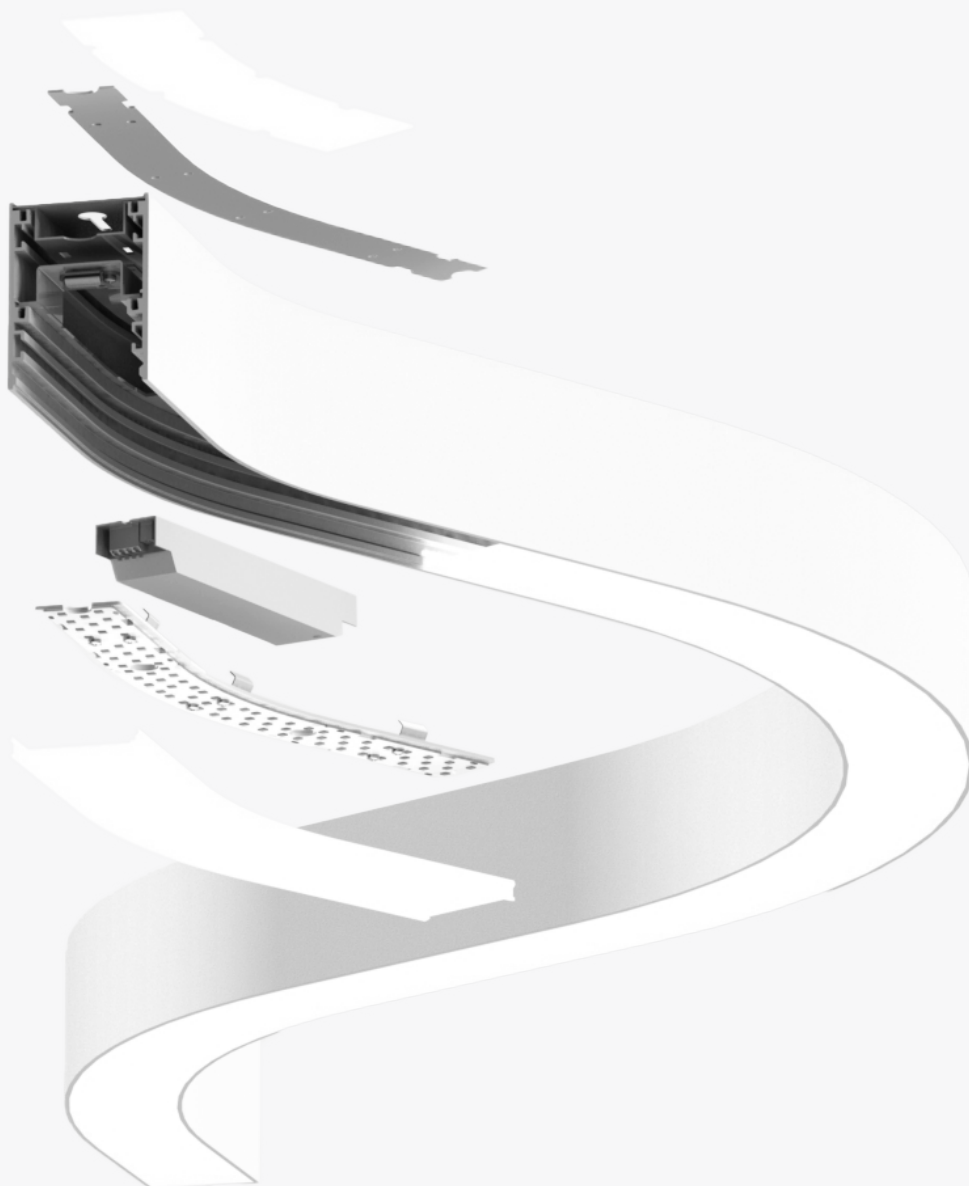

STANDARD

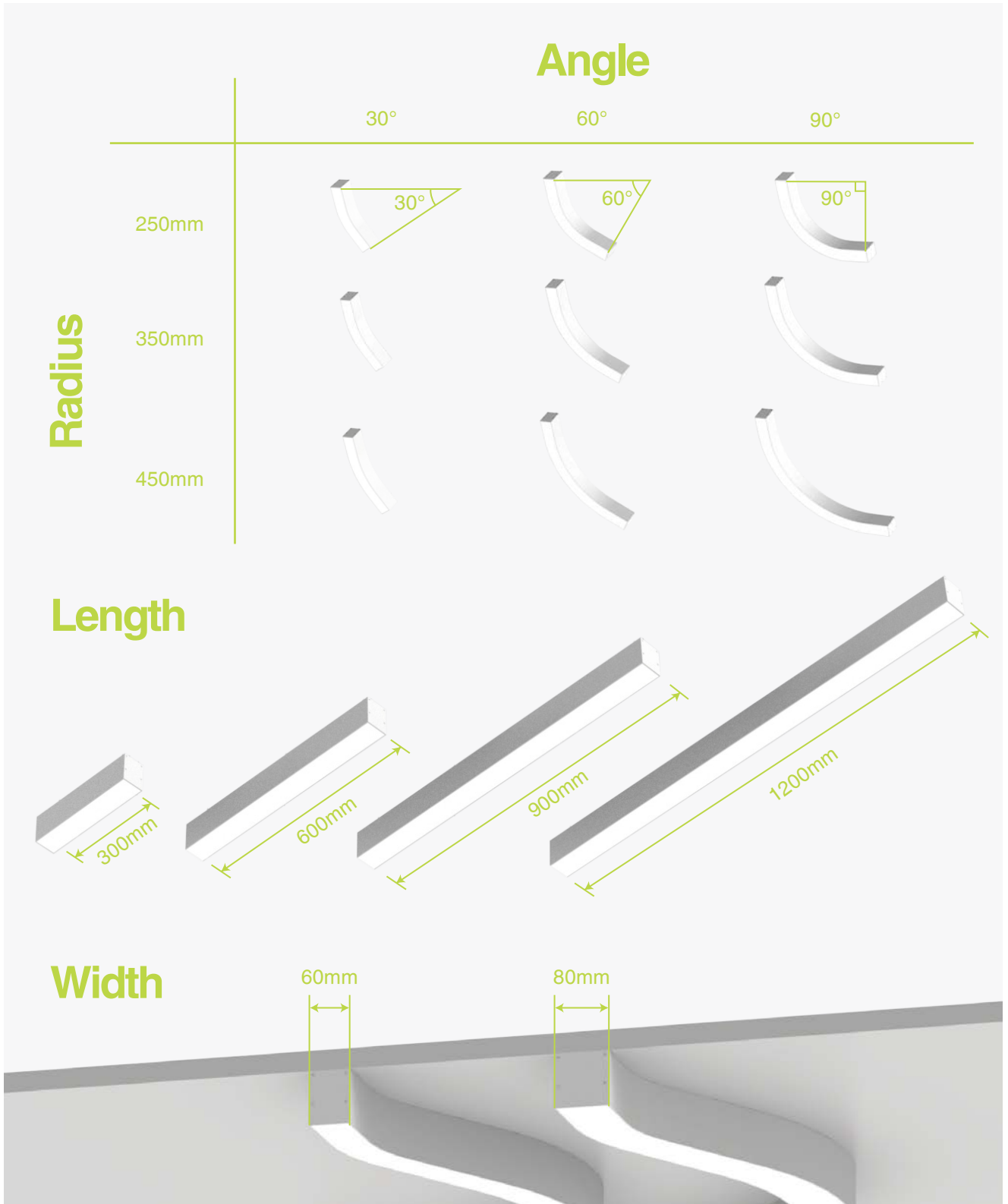

CUSTOM-MADE

*** Customised on request

Bend Angle

Every 30° by LED module in the profile for modularised parts

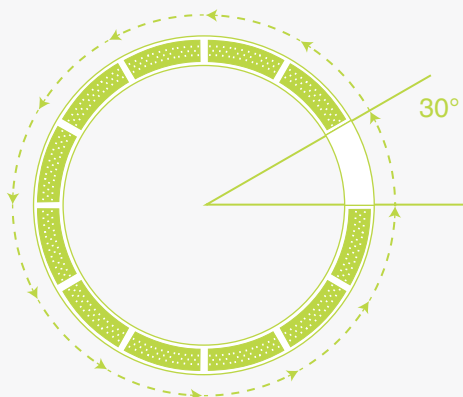

Min 30° for custom-made

R450mm

R350mm

R250mm

Curvature

Radius : Min. 250mm
... No upper limit

*** Min. 200mm without integrated driver

Length

Min. 300mm
Max. 3000mm

50mm per cut



Width

Min. 60mm
Max. 200mm

*** Min. 40mm without integrated driver



Curvity 60

- LED system in aluminium extrusion body
- Custom length available
- Inclusive of mounting accessories
- Integrated LED Driver
- Custom size available upon request
- Easy maintenance design

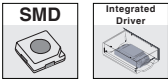

Standard Version

MX 5531 **M** - **G2** - - -

Code	Direction	Code	Application	Code	Curvature	Code	Bend Angle	Code	CRI	Code	CCT	Code	Aluminium Housing Colour
D	Downlight	P	Pendant	0300	Straight Length 300mm	SS	Straight	9	90	27	2700K	B	Black Body
N	Up & Downlight	S	Surface Mounted	0600	Straight Length 600mm	30	30°	F	Full Spectrum 97	30	3000K	W	White Body
				0900	Straight Length 900mm	60	60°			35	3500K		
				1200	Straight Length 1200mm	90	90°			40	4000K		
				R250	Curve Radius 250mm								
				R350	Curve Radius 350mm								
				R450	Curve Radius 450mm								

Downward

- Per 1000mm, 32W, 4090lm, CRI90
- Per 1000mm, 32W, 3480lm, Full Spectrum CRI97

Upward

- Per 1000mm, 15W, 2200lm, CRI90
- Per 1000mm, 15W, 1870lm, Full Spectrum CRI97

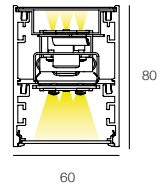

Custom-made Version

*** Quotation will be issued based on submitted design drawing.

MX 5531 **M** - **G2** - - **PM**

Code	Direction	Code	Application	Code	CRI	Code	CCT	Code	Aluminium Housing Colour
D	Downlight	P	Pendant	9	90	27	2700K	B	Black Body
N	Up & Downlight	S	Surface Mounted	F	Full Spectrum 97	30	3000K	W	White Body
						35	3500K		
						40	4000K		

Downward

- Per 1000mm, 32W, 4090lm, CRI90
- Per 1000mm, 32W, 3480lm, Full Spectrum CRI97

Upward

- Per 1000mm, 15W, 2200lm, CRI90
- Per 1000mm, 15W, 1870lm, Full Spectrum CRI97

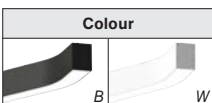
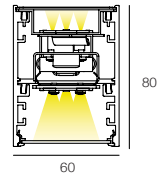

Curve Profile Technical Specification See Page 38

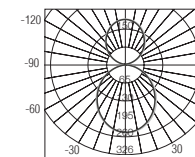

MX 5531NMP-G2-0300-SS-930

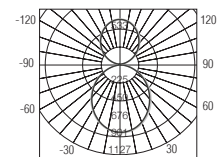

MX 5531NMP-G2-1000-SS-930

Accessory

Mounting Accessories included in each set

Pendant Accessory



Pendant suspension x 2pcs with 1500mm wire



Cable base with 3 x 0.75mm² cable, 1500mm in length
5 x 0.75mm² version for 2 circuits available on request

Recess Accessory



Recess mount x 2pcs

Curvity 80

- LED system in aluminium extrusion body
- Custom length available
- Inclusive of mounting accessories
- Integrated LED Driver
- Custom size available upon request
- Easy maintenance design

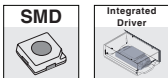

Standard Version

MX 5532 **M** - **G2** - - -

Code	Direction	Code	Application	Code	Curvature	Code	Bend Angle	Code	CRI	Code	CCT	Code	Aluminium Housing Colour
D	Downlight	P	Pendant	0300	Straight Length 300mm	SS	Straight	9	90	27	2700K	B	Black Body
N	Up & Downlight	S	Surface Mounted	0600	Straight Length 600mm	30	30°	F	Full Spectrum 97	30	3000K	W	White Body
				0900	Straight Length 900mm	60	60°			35	3500K		
				1200	Straight Length 1200mm	90	90°			40	4000K		
				R250	Curve Radius 250mm								
				R350	Curve Radius 350mm								
				R450	Curve Radius 450mm								

Downward

- Per 1000mm, 32W, 4090lm, CRI90
- Per 1000mm, 32W, 3480lm, Full Spectrum CRI97

Upward

- Per 1000mm, 15W, 2200lm, CRI90
- Per 1000mm, 15W, 1870lm, Full Spectrum CRI97

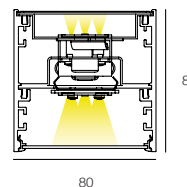

Custom-made Version *** Quotation will be issued based on submitted design drawing.

MX 5532 **M** - **G2** - - - **PM**

Code	Direction	Code	Application	Code	CRI	Code	CCT	Code	Aluminium Housing Colour
D	Downlight	P	Pendant	9	90	27	2700K	B	Black Body
N	Up & Downlight	S	Surface Mounted	F	Full Spectrum 97	30	3000K	W	White Body
						35	3500K		
						40	4000K		

Downward

- Per 1000mm, 32W, 4090lm, CRI90
- Per 1000mm, 32W, 3480lm, Full Spectrum CRI97

Upward

- Per 1000mm, 15W, 2200lm, CRI90
- Per 1000mm, 15W, 1870lm, Full Spectrum CRI97

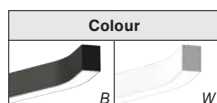
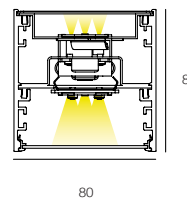

Curve Profile Technical Specification See Page 38

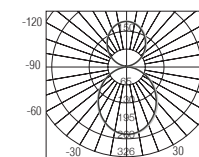

MX 5532NMP-G2-0300-SS-930

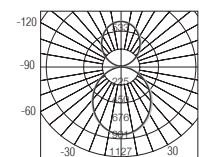

MX 5532NMP-G2-1000-SS-930

Accessory

Mounting Accessories included in each set

Pendant Accessory



Pendant suspension x 2pcs with 1500mm wire



Cable base with 3 x 0.75mm² cable, 1500mm in length
5 x 0.75mm² version for 2 circuits available on request

Recess Accessory



Recess mount x 2pcs

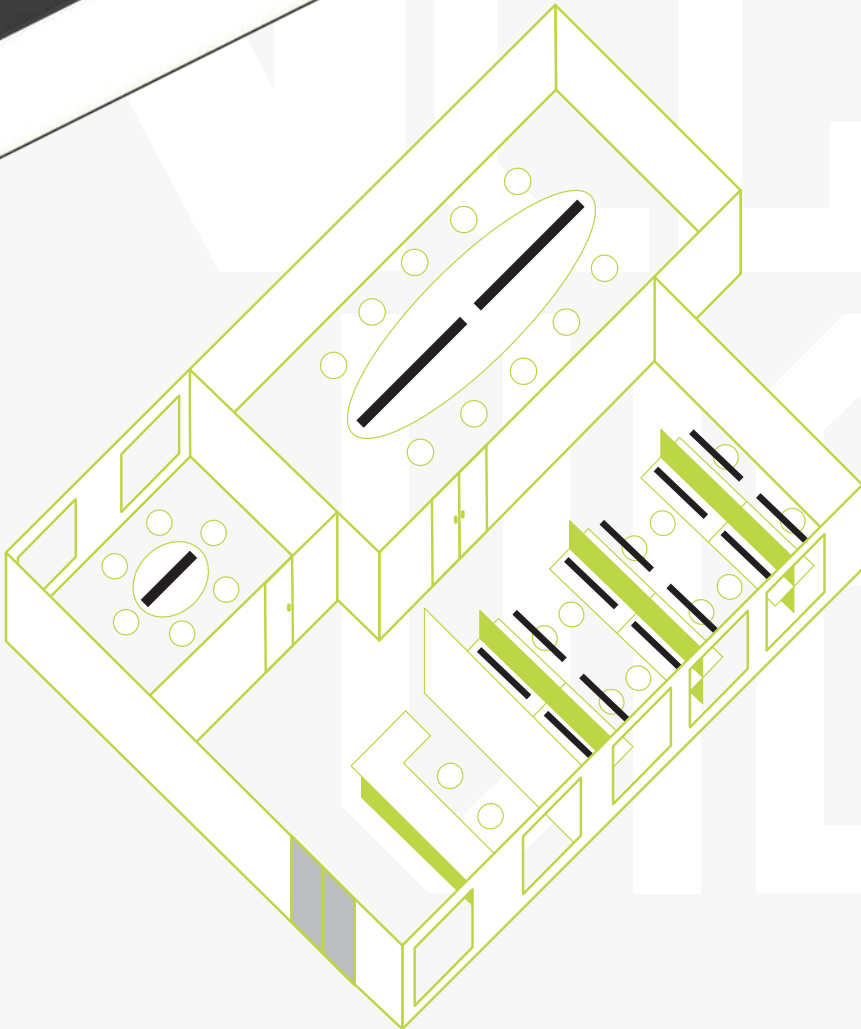
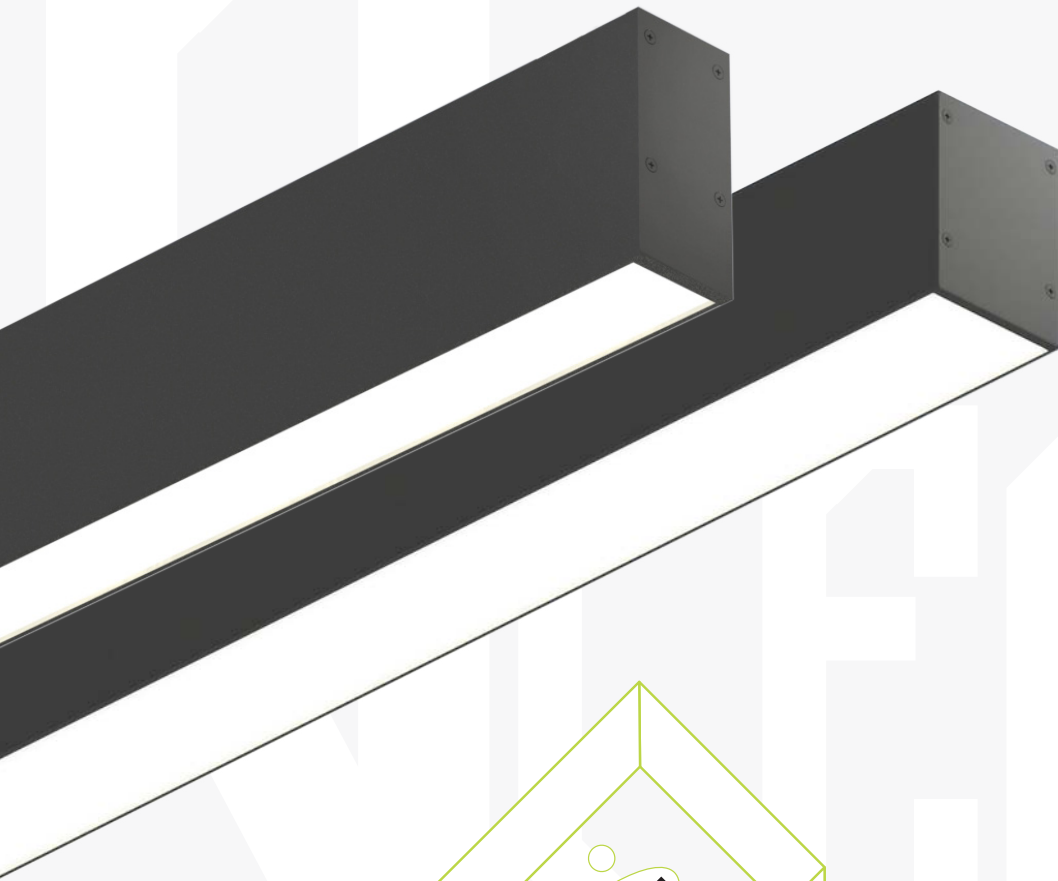

AND

Multi-Directional Light

ClearView and PureView are our most powerful profile with best visual comfort to date, and up and downlight to provide ample lumen to your space.

Unparalleled Visual Comfort

The unique anti-glare diffuser combination ensures low UGR while maintaining a high lumen output. With the various diffuser options, the possibilities are endless with ClearView and PureView.

Easy Maintenance Mechanism (Front Panel Access)

Installation and maintenance have not been easier. A newly developed front diffuser removal and easy connecting mechanism allows individuals to service the lamp without the need to uninstall the light.

CLEARVIEW & PUREVIEW

PUREVIEW

EASY

MAINTENANCE MECHANISM

FRONT

PANEL ACCESS

« Glare-free,
brilliantly bright office! »

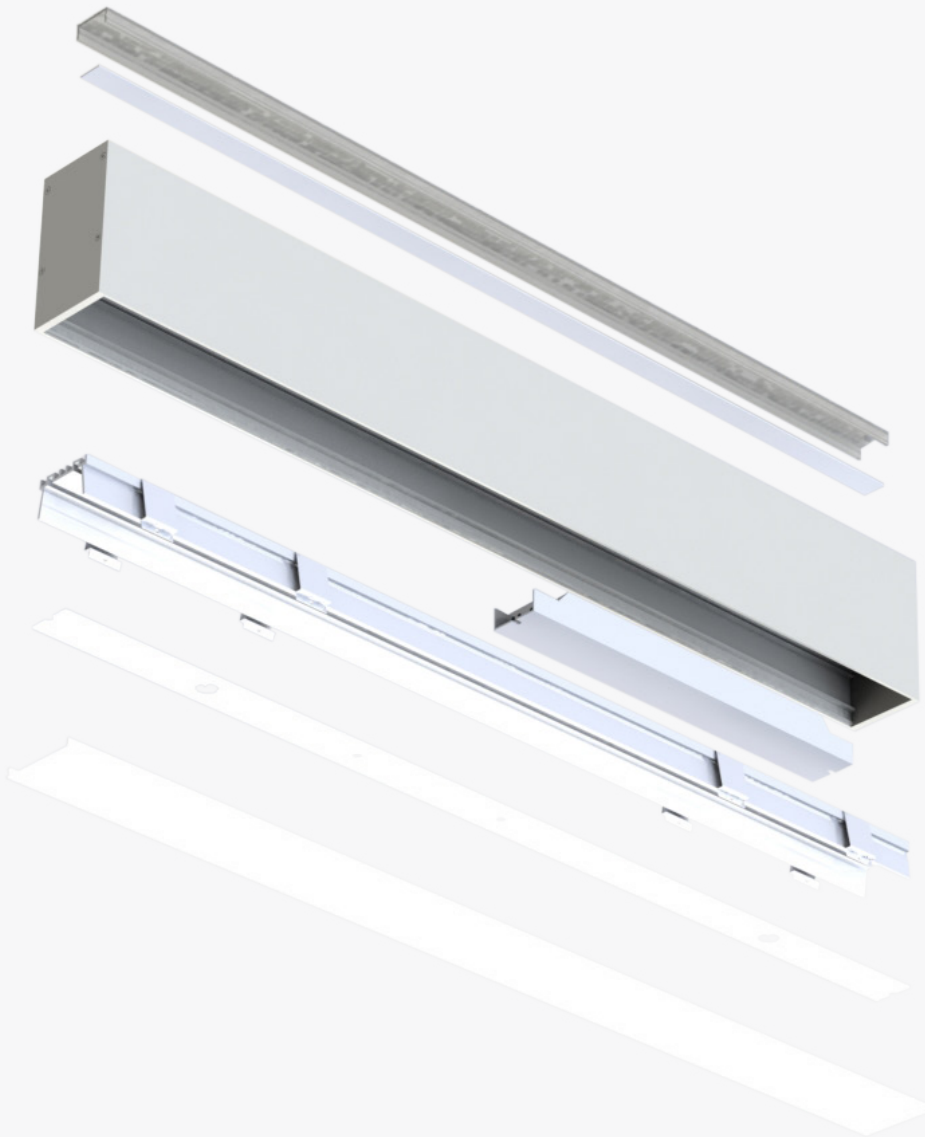

ClearView

- LED system in aluminium extrusion body
- Custom length available
- Inclusive of mounting accessories
- Integrated LED Driver
- Custom size available upon request
- Easy maintenance design

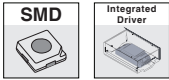

MX 5523 - G2 - 600 -

Code	Direction	Code	Diffuser	Code	Application	Code	CRI	Code	CCT	Code	Aluminium Housing Colour
D	Downlight	P	Prismatic	P	Pendant	9	90	27	2700K	B	Black Body
N	Up & Downlight	M	Milky White PC	S	Surface Mounted	F	Full Spectrum 97	30	3000K	W	White Body
								35	3500K		
								40	4000K		

Downward

- 11.3W 400mA 1560lm, CRI90, SMD LED, Integrated LED Driver
- 11.3W 400mA 1332lm, CRI97, SMD LED, Integrated LED Driver

Upward

- 5.5W 200mA 900lm, CRI90, SMD LED, Integrated LED Driver
- 5.5W 200mA 638lm, CRI97, SMD LED, Integrated LED Driver

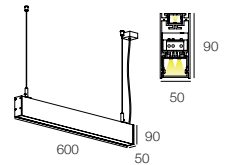

MX 5523 - G2 - 900 -

Code	Direction	Code	Diffuser	Code	Application	Code	CRI	Code	CCT	Code	Aluminium Housing Colour
D	Downlight	P	Prismatic	P	Pendant	9	90	27	2700K	B	Black Body
N	Up & Downlight	M	Milky White PC	S	Surface Mounted	F	Full Spectrum 97	30	3000K	W	White Body
								35	3500K		
								40	4000K		

Downward

- 16.9W 600mA 2340lm, CRI90, SMD LED, Integrated LED Driver
- 16.9W 600mA 1998lm, CRI97, SMD LED, Integrated LED Driver

Upward

- 8.2W 300mA 1350lm, CRI90, SMD LED, Integrated LED Driver
- 8.2W 300mA 958lm, CRI97, SMD LED, Integrated LED Driver

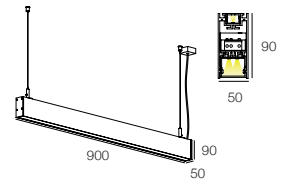

MX 5523 - G2 - 1200 -

Code	Direction	Code	Diffuser	Code	Application	Code	CRI	Code	CCT	Code	Aluminium Housing Colour
D	Downlight	P	Prismatic	P	Pendant	9	90	27	2700K	B	Black Body
N	Up & Downlight	M	Milky White PC	S	Surface Mounted	F	Full Spectrum 97	30	3000K	W	White Body
								35	3500K		
								40	4000K		

Downward

- 22.6W 800mA 3120lm, CRI90, SMD LED, Integrated LED Driver
- 22.6W 800mA 2664lm, CRI97, SMD LED, Integrated LED Driver

Upward

- 10.9W 400mA 1800lm, CRI90, SMD LED, Integrated LED Driver
- 10.9W 400mA 1277lm, CRI97, SMD LED, Integrated LED Driver

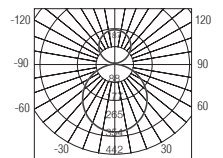
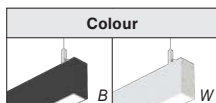
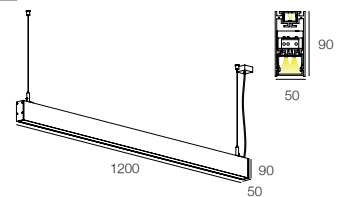

MX 5523NMP-G2-600-930

Accessory

Mounting Accessories included in each set

Pendant Accessory



Cable base with 3 x 0.75mm² cable, 1500mm in length
5 x 0.75mm² version for 2 circuits available on request

PureView

- LED system in aluminium extrusion body
- Custom length available
- Inclusive of mounting accessories
- Integrated LED Driver
- Custom size available upon request
- Easy maintenance design

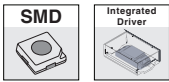

MX 5524 - G2 - 600 -

Code	Direction	Code	Diffuser	Code	Application	Code	CRI	Code	CCT	Code	Aluminium Housing Colour
D	Downlight	P	Prismatic	P	Pendant	9	90	27	2700K	B	Black Body
N	Up & Downlight	M	Milky White PC	S	Surface Mounted	F	Full Spectrum 97	30	3000K	W	White Body
								35	3500K		
								40	4000K		

Downward

- 11.0W 400mA 1602lm, CRI90, SMD LED, Integrated LED Driver
- 11.0W 400mA 1368lm, CRI97, SMD LED, Integrated LED Driver

Upward

- 5.5W 200mA 900lm, CRI90, SMD LED, Integrated LED Driver
- 5.5W 200mA 638lm, CRI97, SMD LED, Integrated LED Driver

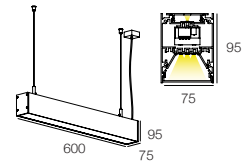

MX 5524 - G2 - 900 -

Code	Direction	Code	Diffuser	Code	Application	Code	CRI	Code	CCT	Code	Aluminium Housing Colour
D	Downlight	P	Prismatic	P	Pendant	9	90	27	2700K	B	Black Body
N	Up & Downlight	M	Milky White PC	S	Surface Mounted	F	Full Spectrum 97	30	3000K	W	White Body
								35	3500K		
								40	4000K		

Downward

- 16.6W 600mA 2403lm, CRI90, SMD LED, Integrated LED Driver
- 16.6W 600mA 2052lm, CRI97, SMD LED, Integrated LED Driver

Upward

- 8.2W 300mA 1350lm, CRI90, SMD LED, Integrated LED Driver
- 8.2W 300mA 958lm, CRI97, SMD LED, Integrated LED Driver

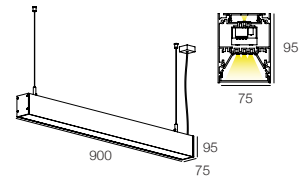

MX 5524 - G2 - 1200 -

Code	Direction	Code	Diffuser	Code	Application	Code	CRI	Code	CCT	Code	Aluminium Housing Colour
D	Downlight	P	Prismatic	P	Pendant	9	90	27	2700K	B	Black Body
N	Up & Downlight	M	Milky White PC	S	Surface Mounted	F	Full Spectrum 97	30	3000K	W	White Body
								35	3500K		
								40	4000K		

Downward

- 22.1W 800mA 3204lm, CRI90, SMD LED, Integrated LED Driver
- 22.1W 800mA 2736lm, CRI97, SMD LED, Integrated LED Driver

Upward

- 10.9W 400mA 1800lm, CRI90, SMD LED, Integrated LED Driver
- 10.9W 400mA 1277lm, CRI97, SMD LED, Integrated LED Driver

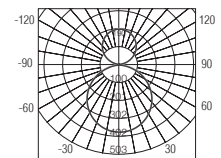
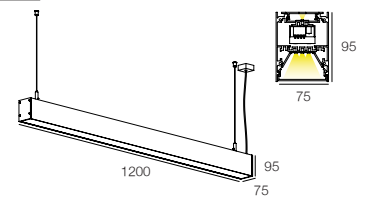

MX 5524NMP-G2-600-930

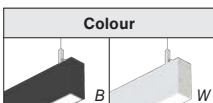

Accessory

Mounting Accessories included in each set

Pendant Accessory

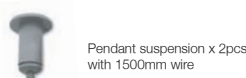

Cable base with 3 x 0.75mm² cable, 1500mm in length
5 x 0.75mm² version for 2 circuits available on request

FREEPLUS

LED
MODULE
REPLACEMENT
SYSTEM

FreePlus LED module is compatible with 13 series in the Milux Collection. The FreePlus modules also offer a wide range of options on CCT, CRI, LED Technology, Beam Angle and Efficacy.

The FreePlus LED module is a complete solution to any project type that needs to satisfy a wide range of parameters, whilst providing flexibility to replace the LED module for maintenance.

- Full spectrum
- 8°
- RGBCW



*“Module transformed,
Lighting your way.”*

FULL



Full spectrum LED lighting is designed to replicate natural daylight and has numerous benefits. It can improve human health, enhance color perception, and promote plant growth. Full spectrum lights are often used to supplement natural daylight, helping you feel better, see better, and grow better.

The spectrum of full spectrum LED lamps simulates sunlight and can be adjusted to match the light intensity and color temperature of different times of the day and seasons. This allows them to cater to the growth patterns of organisms.

FULL SPECTRUM

How does Full spectrum LED lighting AFFECT SLEEP?

Full spectrum LED lighting can have a significant impact on sleep quality. Light plays a central role in regulating the body's internal clock, known as the circadian rhythm, which signals when to be alert and when to rest. Exposure to natural light helps keep the circadian rhythm synchronized with sunrise and sunset, promoting wakefulness during the day and sleep at night. However, artificial light sources, including full spectrum LED lights, can disrupt this natural rhythm.

The production of melatonin, an essential sleep-promoting hormone, is closely tied to light exposure. In response to darkness, the pineal gland in the brain initiates melatonin production, which promotes drowsiness and facilitates sleep. Conversely, exposure to light, especially blue light emitted by LEDs, can suppress melatonin secretion and interfere with sleep. This can negatively affect your ability to fall asleep, remain asleep, and sleep for an extended period of time.

On the other hand, full spectrum light therapy has been found to have positive effects on sleep. Researchers have observed that full spectrum light therapy improves morning alertness, decreases the need for daytime sleep, increases sleep time during the night, and enhances overall sleep duration. These benefits contribute to a longer and deeper night's rest.

In summary, while exposure to natural light is beneficial for maintaining a healthy sleep-wake cycle, excessive or poorly timed artificial light exposure can disrupt circadian rhythms and melatonin production. However, full spectrum light therapy has shown promising results in improving sleep quality.

Non-Image Forming Brain Pathways

Blue light penetrates our eyes and signals a specific set of photoreceptors present in the retinal epithelium, called ipRGCs (intrinsically photosensitive Retinal Ganglion Cells). They are one of three types of photoreceptors in the retina, along with rods and cones. Rods and cones are the main image forming receptors.



Our Freeplus 8° is the latest addition to our Freeplus family and it provides excellent narrow spotlight onto the target. Combined with COB up to 10W power output and our Freeplus compatible luminaires, Freeplus 8° completes the family as one of our most flexible products to date.

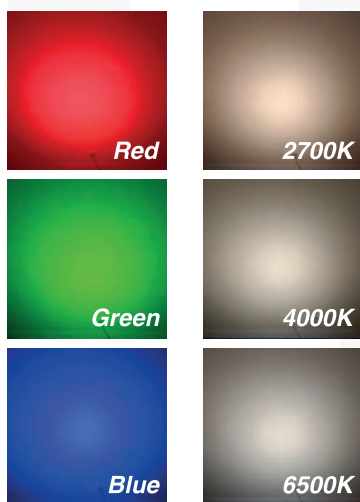

RGBCW

Research indicates colour plays an important role in affecting our mood and health. Blue light suppresses levels of melatonin, helping us stay awake and alert, while red light increases levels of melatonin, helping our bodies get ready for bed.

Our modules with RGBCW chips can be used in various application in household, office, shops, malls, and hospitals. The colour and colour temperature can be adjusted easily accordingly in connection with a control system.

R = RED

G = GREEN

B = BLUE

C = COOL WHITE

W = WARM WHITE

Freeplus Full Spectrum

LED Module Powered by **bridgelux**

- Full Beam Angle Options: Narrow, Medium, Wide
- 4 CCT Options: 2700K, 3000K, 3500K, 4000K
- SDCM 3 MacAdam Ellipses
- Projected Life Time 50K hours L70



Full Spectrum Module

..... - **G7** - [] [] [] - [] []

Code	CCT	Code	Beam Angle
F27	2700K	20	20°
F30	3000K	30	30°
F35	3500K	40	40°
F40	4000K		

10.2W 300mA 1219lm, CRI95

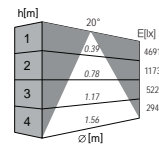
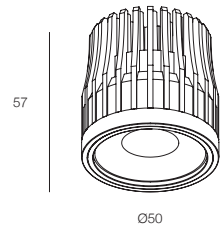

COB Module CRI95 20°

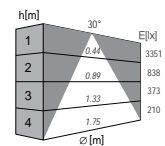

COB Module CRI95 30°

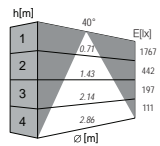

COB Module CRI95 40°

LED Driver

Ordering Code	Driving Power Range	Matching with LED Fitting	Output Current	Wiring Box Dimension (mm) (L) x (W) x (H)	Cut Hole (mm)
EC LED-300mA-12-DN(42)	8 - 12W	Freeplus Full Spectrum	300mA	220 x 45 x 30	Ø54
EC LED-SETmA-M20D-MiAM-TCI(40)	6 - 15W		300mA, 1-10V Dimmable	250 x 65 x 40	Ø78

Freeplus 8° COB Module

LED Module Powered by  bridgelux.

- Narrow Spot with 8° beam angle
- Field/ Beam Ratio 2.0
- 4 CCT Options: 2700K, 3000K, 3500K, 4000K
- SDCM 3 MacAdam Ellipses
- Projected Life Time 50K hours L70

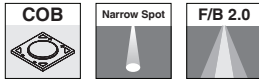

Narrow Spot COB Module

..... - V4G7 - □ - □ - 8 - ...

Code	CRI	Code	CCT
8	80	27	2700K
9	90	30	3000K
F	Full Spectrum 95	35	3500K
		40	4000K

- 9.2W 240mA 1133lm, CRI80
- 9.2W 240mA 920lm, CRI90
- 9.1W 240mA 765lm, Full Spectrum CRI95

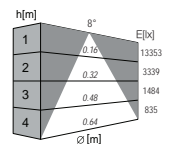
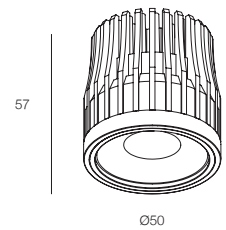

**Narrow Spot 8°
COB Module CRI90**

LED Driver

Ordering Code	Driving Power Range	Matching with LED Fitting	Output Current	Wiring Box Dimension(mm) (L) x (W) x (H)	Cut Hole (mm)
EC LED-240mA-12-DN(42)	6 - 10W	Freeplus 8° COB Module	240mA	220 x 45 x 30	Ø54
EC LED-SETmA-M20D-MiAM-TCI(40)	5 - 13W		240mA, 1-10V Dimmable	250 x 65 x 40	Ø78

FreePlus RGBCW Module

- Ultra Wide 50° beam angle
- Tunable White
- Tunable RGB
- Bluetooth / DMX control available
- CCT vary from 2700K to 6000K



..... - G7 - RGBCW9 - 50

- 5.2W 200mA, Red
- 10.4W 400mA, Green
- 10.4W 400mA, Blue
- 10.4W 400mA 1092lm, Cold White 6000K, CRI90
- 10.4W 400mA 936lm, Warm White 2700K, CRI90

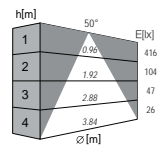
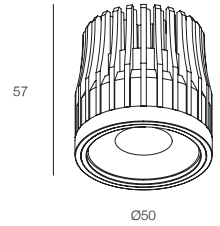

Freeplus RGBCW 50°

LED Driver

Ordering Code	Driving Power Range	Matching with LED Fitting	Output Current	Wiring Box Dimension (mm) (L) x (W) x (H)	Cut Hole (mm)
EC LED-48V-200-MW(34)	0 - 200W	FreePlus RGBCW Module	48V	290 x 130 x 41	Ø138
EC LED-DMX5C-EU(40)	1 - 187W		400mA	250 x 65 x 40	Ø78
EC LED-BT5CH-LV(40)	25W				

Renia

- Recessed downlight for FreePlus module
- Die cast aluminium body available in 2 colours
- Adjustable and fixed version available
- Separate order of remote LED driver available upon request

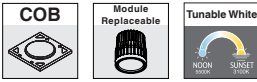
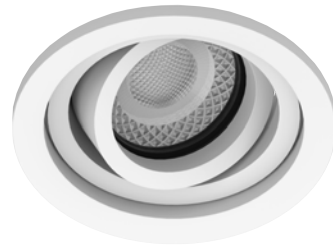

Fixed Version

MX 7490 - -

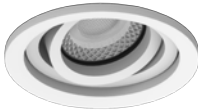

*Please refer to P.29-31 for the FreePlus Module Matrix

Code	Colour
80	White
10	Black

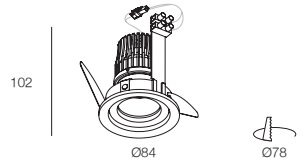

Adjustable Version

MX 7491 - -



*Please refer to P.29-31 for the FreePlus Module Matrix

Code	Colour
80	White
10	Black

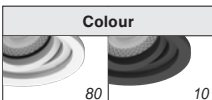
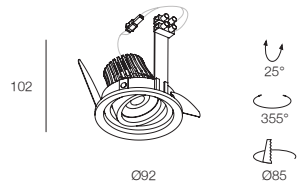

Accessories See Page 38

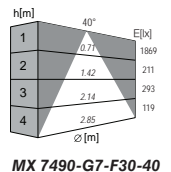
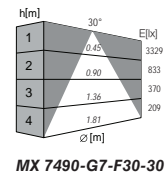
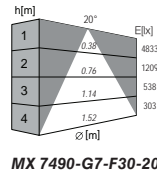
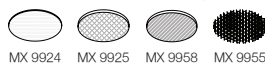

Accessory

Anti-Glare tube (Black)

MX 5949 - 10

Overall height increase by 20 mm

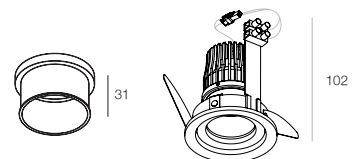

Renia + MX 5949-10

Glee

- Recessed downlight for FreePlus Module
- Die cast aluminium trim
- Polycarbonate secondary optics with various colours options
- Downlight and wallwasher version available
- Separate order of remote LED driver available upon request

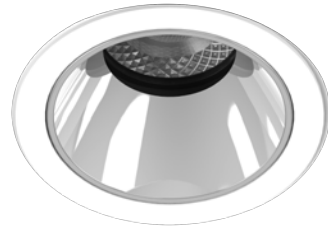

Downlight Version

MX 7480 - -

*Please refer to P.29-31 for the FreePlus Module Matrix

Code	Colour
82	White Trim & Black Reflector
84	White Trim & Silver Reflector
86	White Trim & Sandblasted Reflector
89	White Trim & Rose Gold Reflector

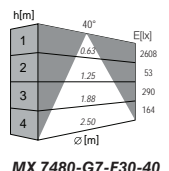
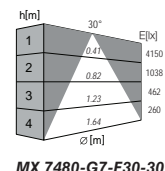
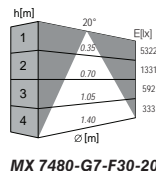
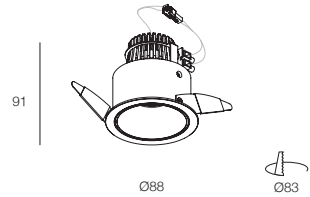

Pin Hole

- Recessed downlight for FreePlus module
- Adjustable and fixed version available
- Die cast aluminium body available in 2 colours
- Separate order of remote LED driver available upon request

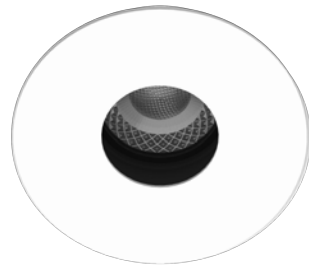

Adjustable Version

MX 7425 □ - - □ □

Code	Mounting Method		Code	Colour
-Blank-	Standard Mount	*Please refer to P.29-31 for the FreePlus Module Matrix	80	White
F	Flush Mount Kit/ Installation Kit		10	Black

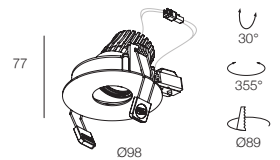

Adjustable Version with Cover Glass, IP55

MX 7425C □ - - □ □

Code	Mounting Method		Code	Colour
-Blank-	Standard Mount	*Please refer to P.29-31 for the FreePlus Module Matrix	80	White
F	Flush Mount Kit/ Installation Kit		10	Black

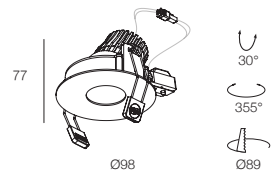

Fixed Version

MX 7426 □ - - □ □

Code	Mounting Method		Code	Colour
-Blank-	Standard Mount	*Please refer to P.29-31 for the FreePlus Module Matrix	80	White
F	Flush Mount Kit/ Installation Kit		10	Black

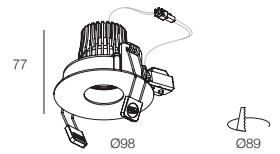

Fixed Version with Cover Glass, IP55

MX 7426C □ - - □ □

Code	Mounting Method		Code	Colour
-Blank-	Standard Mount	*Please refer to P.29-31 for the FreePlus Module Matrix	80	White
F	Flush Mount Kit/ Installation Kit		10	Black

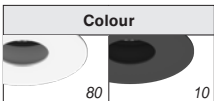
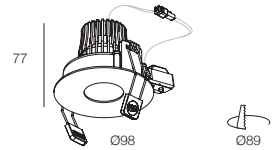

Accessories See Page 38

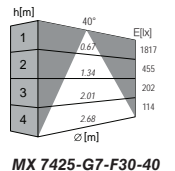
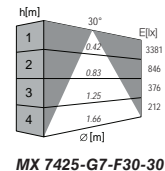
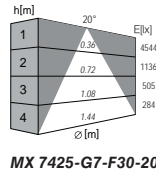
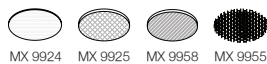

MX 7425-G7-F30-20

MX 7425-G7-F30-30

MX 7425-G7-F30-40

Accessory (*Match with Flush Mount Kit/ Installation Kit Version)

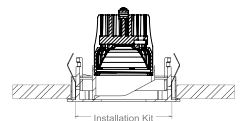
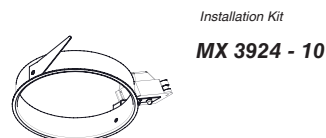
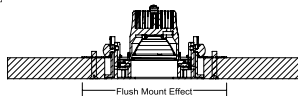
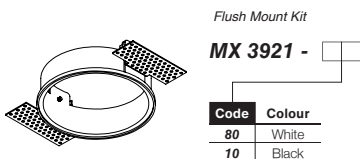

Pin Slot

- Recessed downlight for FreePlus module
- Adjustable version
- Die cast aluminium body available in 2 colours
- Separate order of remote LED driver available upon request



Adjustable Version

MX 7427 □ - - □ □

Code	Mounting Method		Code	Colour
-Blank-	Standard Mount	*Please refer to P.29-31 for the FreePlus Module Matrix	80	White
F	Flush Mount Kit/ Installation Kit		10	Black



Adjustable Version with Cover Glass, IP55

MX 7427C □ - - □ □

Code	Mounting Method		Code	Colour
-Blank-	Standard Mount	*Please refer to P.29-31 for the FreePlus Module Matrix	80	White
F	Flush Mount Kit/ Installation Kit		10	Black

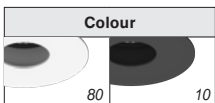
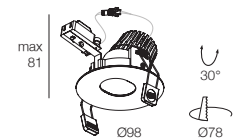

Accessories See Page 38

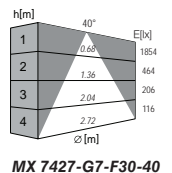
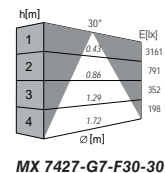
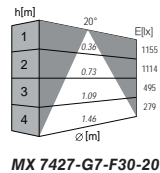
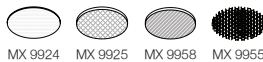

Accessory (*Match with Flush Mount Kit/ Installation Kit Version)

Flush Mount Kit

MX 3921 - □ □

Code	Colour
80	White
10	Black

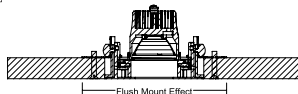

Installation Kit

MX 3924 - 10

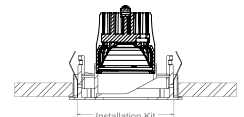

Mini Trim

- Recessed downlight for FreePlus module
- Die cast aluminium body available in 2 colours
- Adjustable and wallwasher version available
- Separate order of remote LED driver available upon request

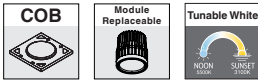

Adjustable Version

MX 7463 - -

*Please refer to P.29-31 for the FreePlus Module Matrix

Code	Colour
80	White
10	Black

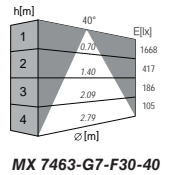
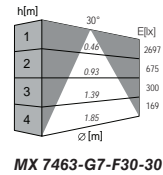
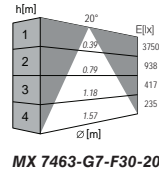
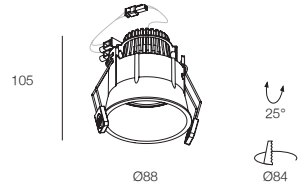

Wallwasher Version

MX 7478 - -

*Please refer to P.29-30 for the FreePlus Module Matrix

Code	Colour
80	White
10	Black

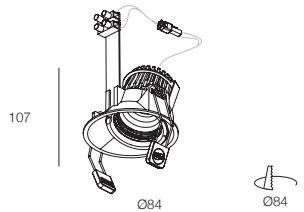

Accessories See Page 38

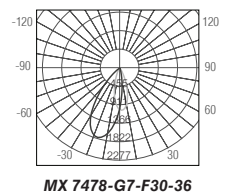
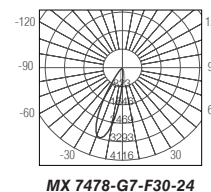
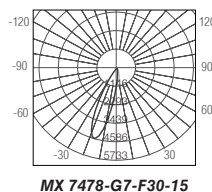
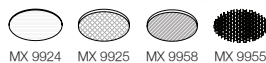

Mini Trim Sq

- Recessed downlight for FreePlus module
- Polycarbonate reflector
- Die cast aluminium body available in 2 colours
- Adjustable and fixed version available
- Separate order of remote LED driver available upon request



Fixed Version

MX 7460 - -

*Please refer to P.29-31 for the FreePlus Module Matrix

Code	Colour
80	White
10	Black

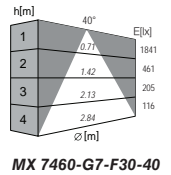
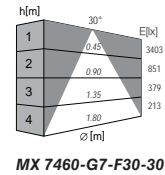
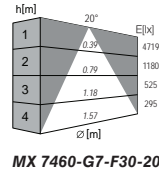
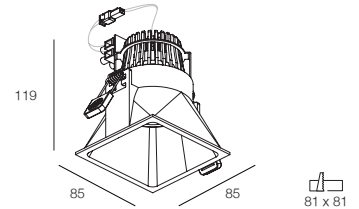

Adjustable Version

MX 7462 - -

*Please refer to P.29-31 for the FreePlus Module Matrix

Code	Colour
80	White
10	Black

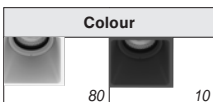
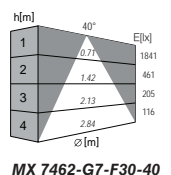
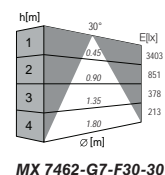
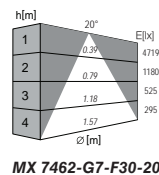
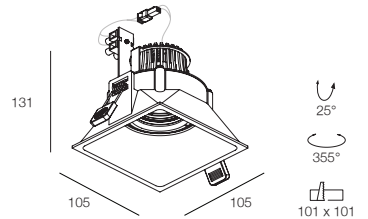

Accessories See Page 38

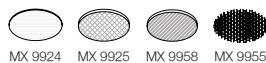

Curve Profile Technical Specification

Output at 3000k	Curvature	Bend Angle	Up and Downlight			Downlight		
			Power (Watt)	Standard (CRI90 lm)	Full Spectrum (CRI97 lm)	Power (Watt)	Standard (CRI90 lm)	Full Spectrum (CRI97 lm)
MX 5531 and MX 5532	Curve R250mm	30°	16.5	1982	1688	11.1	1432	1220
		60°	23.5	2926	2492	15.9	2046	1742
		90°	30.6	3870	3296	20.7	2660	2265
	Curve R350mm	30°	18.8	2297	1956	12.7	1637	1394
		60°	28.2	3555	3028	19.1	2455	2091
		90°	37.7	4814	4100	25.4	3274	2788
	Curve R450mm	30°	21.2	2611	2224	14.3	1841	1568
		60°	33.0	4184	3564	22.3	2864	2439
		90°	44.7	5757	4904	30.2	3887	3311
	Straight 300mm	Straight	14.1	1668	1420	9.5	1228	1045
	Straight 600mm	Straight	28.2	3555	3028	19.1	2455	2091
	Straight 900mm	Straight	42.4	5443	4636	28.6	3683	3136
	Straight 1200mm	Straight	56.5	7330	6244	38.1	4910	4182
	Custom	Straight per 100mm	4.7	629	536	3.2	409	348
		R250 per 30°	7.1	944	804	4.8	614	523
		R350 per 30°	9.4	1258	1072	6.4	818	697
R450 per 30°		11.8	1573	1340	7.9	1023	871	

Accessory

- Glass diffuser/ honey comb accessory for selected series
- One accessory can be used in one lamp head
- Accessories can be added after installation

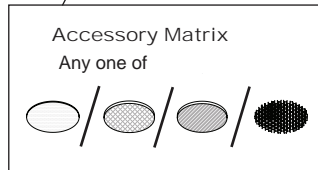
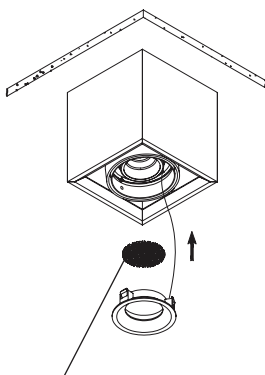

Ø50 Accessory for FreePlus Module



MX 9924

Frosted Glass Diffuser



MX 9925

Obscured Glass Diffuser



MX 9958

Linear Spread Glass Diffuser



MX 9955

Black Honey Comb Louvre

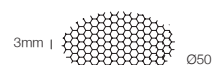

Zodiac 歷程照明有限公司 ZODIAC LIGHTING LIMITED

Head Office — Project Team

1801, 18/F, Hong Man Industrial Centre, 2 Hong Man Street,
Chai Wan, Hong Kong
香港柴灣康民街2號康民工業中心18樓1801室
Tel: +852 2898 9023 Fax: +852 2558 3114

Zodiac Light Hub

1809, 18/F, Hong Man Industrial Centre, 2 Hong Man Street,
Chai Wan, Hong Kong
香港柴灣康民街2號康民工業中心18樓1809室
Tel: +852 2898 9023 Fax: +852 2558 3114

www.zodiaclighting.com